



Quick Installation Guide

TSOL-ESK400-P

Step 1: Open the Easy Solar Kit

Pick the Easy Solar Kit out of the package. Put down it slowly and make the bracket upside. Open the Easy Solar Kit.

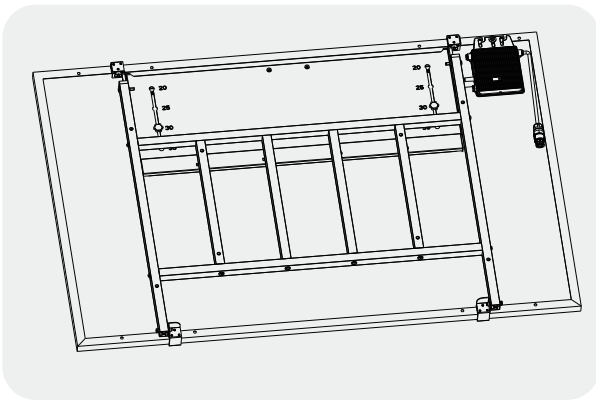

Step 2: Fix the bracket to the base plate

Lift up the base plate and the bracket. Screw on the ESK locks to fix the bracket on the base plate as shown below.

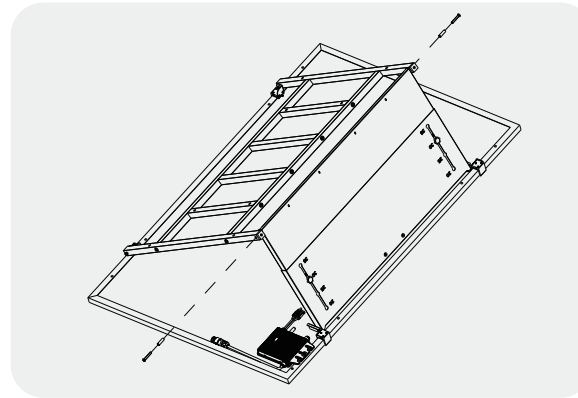

Warning

The bracket must be fixed on the base plate, which will promote the wind loading rating of Easy Solar Kit.

Step 3. Find a suitable location

Turn around the Easy Solar Kit and make the base plate downside. Find a suitable location and put down the Easy Solar Kit lightly. Adjust the direction and make the solar panel facing the sunlight.

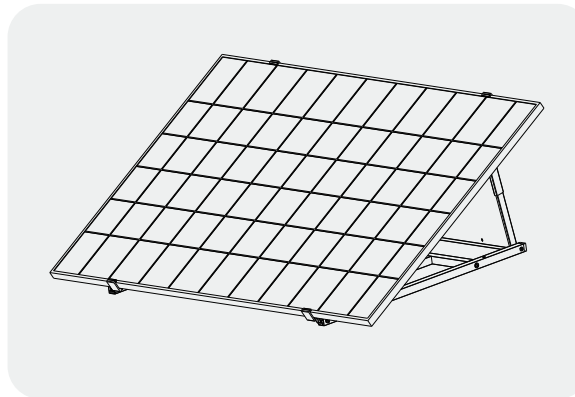

Caution

Please put the Easy Solar Kit on a flat and non-shadow location.

Caution

Easy Solar Kit has a 5m end cable and should be set near the socket. Or use the expansion cable as shown in Step 5.

Step 4. Adjust the angle of bracket (optional)

Angle Lock is an optional function for Easy Solar Kit. There are two angle locks on the bracket.

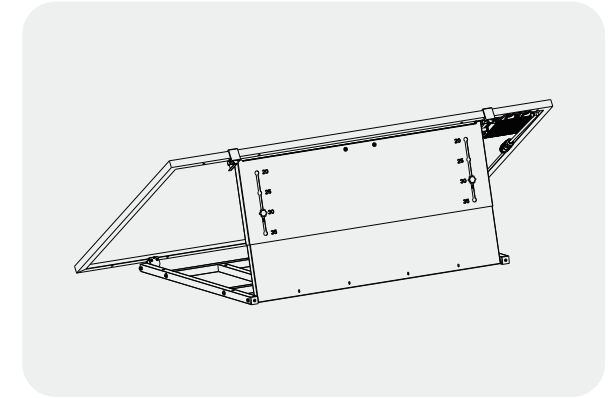

Open the angle locks. Slowly put down the solar panel and make the angle locks slip into the right angle. Then tighten the angle locks again.



Step 5. Extend the end cable (optional)

Extension cable can be used to extend the end cable.
Dismantle the end cable.

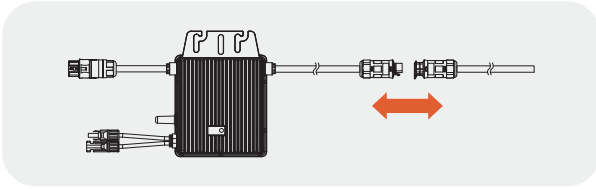

Connect the two sides of extension cable to the microinverter and the end cable.

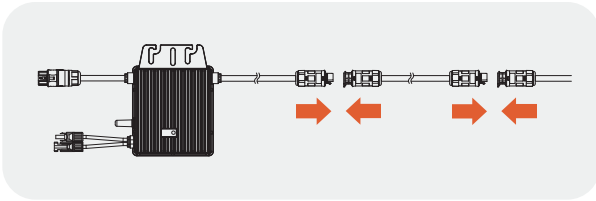

Step 6. Install more Easy Solar Kit (optional)

More Easy Solar Kits can be connected together to form a whole system.

Take out the end cable of the second Easy Solar Kit. Connect the two sides of Extension Cable to the first and second microinverter.

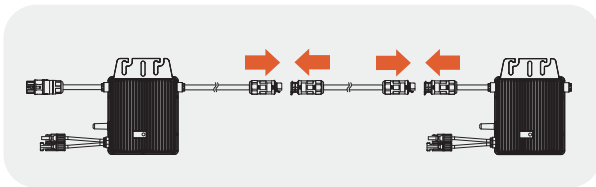

Caution

Because of the current limit of the AC End Cable, the quantity of Easy Solar Kit in the same cable branch should be less than 10.

Step 7. Fix the base plate

Put weights (Brick, Stone etc.) on the base plate to promote the wind loading rating of Easy Solar Kit.

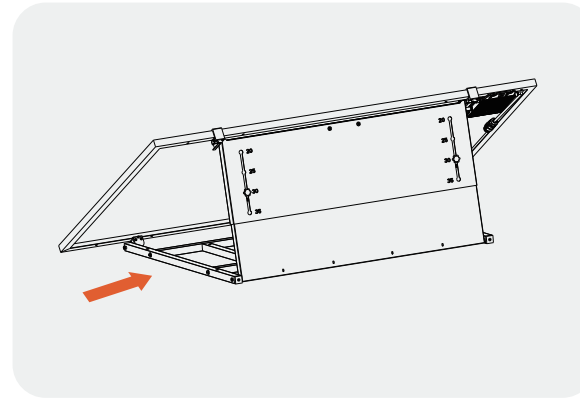

Warning

Weights (Brick, Stone etc.) should be more than 20kg.

Step 8. Start the system

Insert the plug to the socket and the system will start producing power after about a two-minute waiting time.

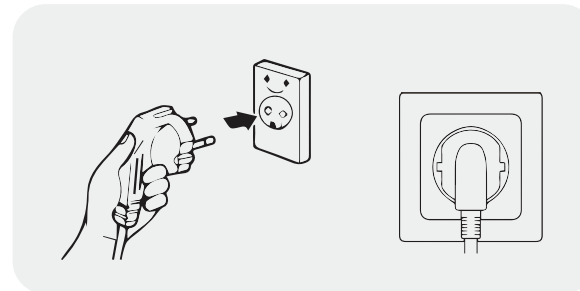

Step 9. Monitoring and other information explanation

After completing the installation, please use the Monitoring User Guide and Monitoring User Manual to download the monitoring platform and register your account.

For more detailed information, please scan the QR code to read.



ESK-Conformity
of Europe



ESK Full Manual

TSUNESS Co., Ltd

E-MAIL : sales@tsun-ess.com

WEB : www.tsun-ess.com

TEL : +86-512-66186028