



User Manual

Balcony Microinverter

Trademarks and Permissions

TSUN and other TSUNESS trademarks are trademarks of TSUNESS Co., Ltd. All other trademarks and trade names mentioned in this document are the property of their respective holders.

TSUNESS Co., Ltd makes no representations express or implied, concerning this documentation or any of the equipment and / or software it may describe, including (with no limitation) any implied warranties of utility, merchantability, or fitness for any particular purpose.

All such warranties are expressly disclaimed. Neither TSUNESS nor its distributors or dealers shall be liable for any indirect, incidental, or consequential damages under any circumstances. (The exclusion of implied warranties may not apply in all cases under some statutes, and thus the above exclusion may not apply.)

Specifications are subject to change without notice. Every attempt has been made to make this document complete, accurate, and up-to-date. Readers are cautioned, however, that TSUNESS reserves the right to make changes without notice and shall not be responsible for any damages, including indirect, incidental, or consequential damages, caused by reliance on the material presented, including, but not limited to, omissions, typographical errors, arithmetical errors or listing errors in the content material.

All trademarks are recognized even if these are not marked separately. Missing designations do not mean that a product or brand is not a registered trademark. All trademarks are recognized as the property of their respective owners.

Product information is subject to change without notice. User documentation is updated frequently; Check www.tsun-ess.com for the latest information. To ensure optimal reliability and meet warranty requirements, the TSUN Microinverter must be installed according to the instructions in this manual. For warranty text refer to www.tsun-ess.com.

© 2022 TSUNESS Co., Ltd All rights reserved.

Content

Trademarks and Permissions	- 1 -
Content	- 2 -
Read This First	- 3 -
Important Safety Information	- 3 -
Product Label	- 3 -
System Introduction	- 4 -
Product Description	- 4 -
Packing List	- 5 -
Microinverter Installation	- 5 -
Pre-installation Check	- 5 -
Installation Steps	- 6 -
TSUN Smart Monitoring guide	- 8 -
Maintenance Guide	- 10 -
Routine Maintenance	- 10 -
Storage and Dismantling	- 10 -
Recycling and Disposal	- 10 -
Warranty Service	- 10 -
Technical Data	- 11 -

Read This First

Dear customer, thank you for choosing the Balcony microinverter from TSUN. We hope you will find our products meet your needs for renewable energy. Meantime, we appreciate your feedback regarding our products.

A solar microinverter, or simply microinverter, is a plug-and-play device used in photovoltaics, that converts direct current (DC) generated by a single solar module to alternating current (AC). The main advantage is that small amounts of shading, debris, or snow lines on any single solar module, or even a complete module failure, do not disproportionately reduce the output of the entire array. Each microinverter harvests optimum power by performing maximum power point tracking (MPPT) for its connected module. Simplicity in system design, lower amperage wires, simplified stock management, and added safety are other factors introduced with the microinverter solution.



This manual contains important instructions for Balcony microinverters and must be read in their entirety before installing or commissioning the equipment. For safety, only qualified technicians, who have received training or have demonstrated skills can maintain this microinverter.

Important Safety Information





During installation, testing, and inspection, adherence to all the handling and safety instructions is mandatory. Failure to do so may result in injury or loss of life and damage to the equipment.



Product Label

The following safety symbols are used in this document. Familiarize yourself with the symbols and their meaning before installing or operating the system.

 DANGER
· indicates a hazardous situation that can result in deadly electric shock hazards, other serious physical injury, or fire hazards.
 WARNING
• indicates directions that must be fully understood and followed in their entirety in order to avoid potential safety hazards including equipment damage or personal injury.
 CAUTION
· indicates that the described operation must not be carried out. The reader should stop using and fully understand the operations explained before proceeding.

The symbols on the microinverter are listed below and illustrated in detail.

Symbol	Description
	This device is directly connected to the public grid, thus all work to the inverter shall only be carried out by qualified personnel.
	The components inside the inverter will release a lot of heat during operation. Do not touch metal plate housing during operation.
	Please read the installation manual first before installation, operation, and maintenance.
	This device SHALL NOT be disposed of in residential waste.
	This device fulfills the requirements of the Radio Equipment Directive. TSUNESS Co., Ltd declares that the radio equipment (Micro inverter) is in compliance with Directive 2014/53/EU. The full text of the EU Declaration of Conformity is available at the following internet address: https://www.tsun-ess.com/File/\$random-2023-07-03-091204-@2a\$-97Z

RoHS	This device complies with the RoHS Directive.
	There is a risk of electric shock during energy conversion. Before releasing the remaining voltage, do not perform any operations and do not enter within 25 centimeters of the surrounding area.
	

System Introduction

The Balcony microinverter is used in grid-tied applications, comprised of two key elements:

- Balcony Microinverter.
- TSUN monitoring system.

The microinverter converts the DC electricity generated by solar panels into AC electricity which is in accordance with the requirements of the public grid and sends the AC into the grid, reducing the load pressure of the grid.

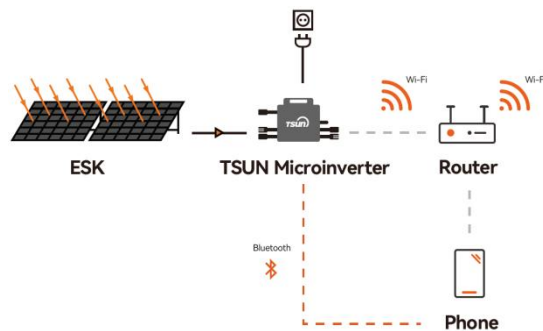

The microinverter is integrated with the Wi-Fi module and connects to the home Wi-Fi router directly. Users can monitor the power generation of the system by TSUN monitoring App.

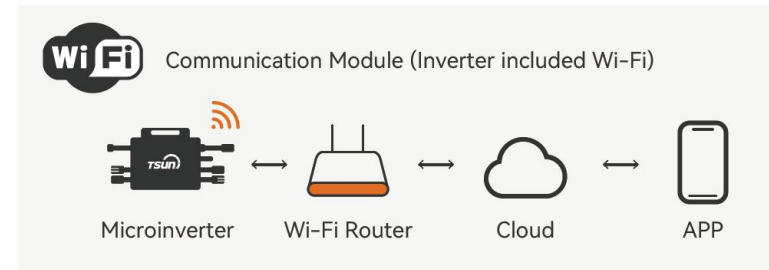

Product Description

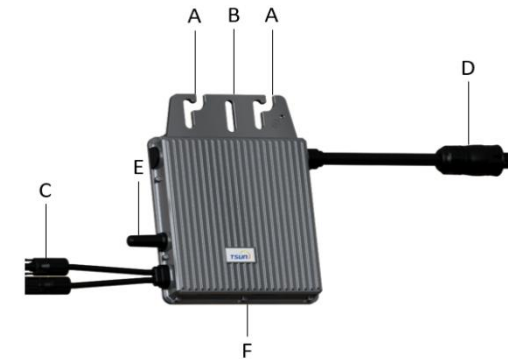

Balcony Microinverter(1PV)

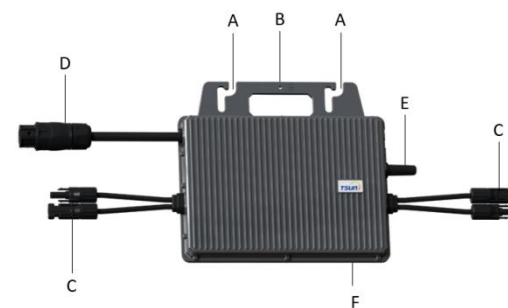

Balcony Microinverter(2PV)

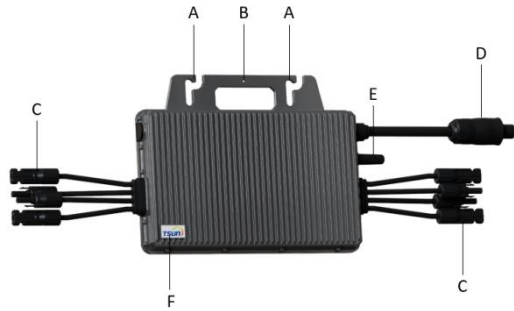

Balcony Microinverter(4PV)

A	Mounting Hole	D	AC Cable
B	Grounding Hole	E	Antenna
C	DC Cables	F	Status Light

Packing List

Serial number	Definition	Graphic
①	Microinverter	
②	Bracket	
③	Stainless steel rolling strip	
④	Allen wrench	
⑤	Buffer strip	
⑥	End Cable	

⑦	Screw M6*16	
⑧	Expansion Screw M8*40	
⑨	Expansion Screw M5*40	

Microinverter Installation

Pre-installation Check

Check the Package

Although TSUN microinverters have surpassed stringent testing and are checked before they leave the factory, it is uncertain that the microinverters may suffer damage during transportation. Please check the package for any obvious signs of damage, and if such evidence is present, do not open the package and contact your dealer as soon as possible.

Check the Installation Environment and Position

When choosing the position of installation, comply with the following conditions:

- ◆ To avoid unwanted power derating due to an increase in the internal temperature of the inverter, do not expose it to direct sunlight.
- ◆ To avoid overheating, always make sure the flow of air around the inverter is not blocked.
- ◆ Do not install in places where gasses or flammable substances may be present.
- ◆ Avoid electromagnetic interference that can compromise the correct operation of electronic equipment.
- ◆ Use a mobile phone to check the Wi-Fi signal strength at the installation position. If the Wi-Fi signal is bad, try to install the microinverter in another position or move the Wi-Fi

router.

Installation Steps



DANGER

- Before installation, check the unit to ensure the absence of any transport or handling damage, which could affect insulation integrity or safety clearances.
- Unauthorized removal of necessary protections, improper use, incorrect installation, and operation may lead to serious safety and shock hazards or equipment damage.
- Be aware that installation of this equipment includes the risk of electric shock.

Step 1. Install the bracket.



WARNING

- Choose the installation location carefully and adhere to specified cooling requirements. Micro-inverter should be installed in a suitable position with good ventilation and no direct sunshine.

➤ Balcony Installation

Choose a suitable position, fix the buffer strip ⑤ on the railing, and then use stainless steel rolling strip ③ to fix the bracket ②.

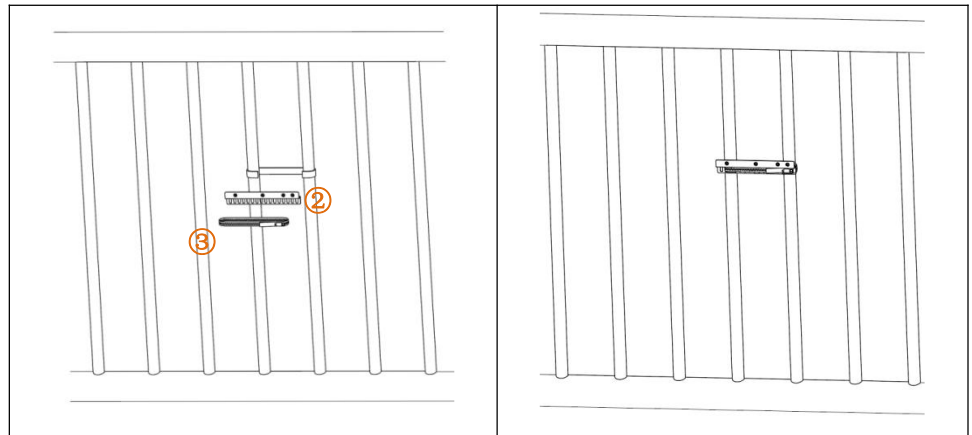
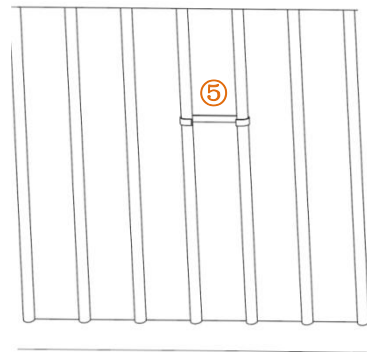

➤ Wall Installation

Fix the bracket to the wall with screws in a suitable position.

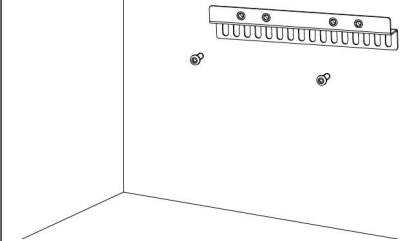

Step 2. Install the Microinverter



DANGER

- Do not install the equipment in adverse environment conditions such as flammable, explosive, corrosive, extreme high or low temperature, and humid.

➤ Balcony Installation

Using two pairs of screws and nuts to fix the microinverter on the frame. Make sure that the label of microinverter should be upside.

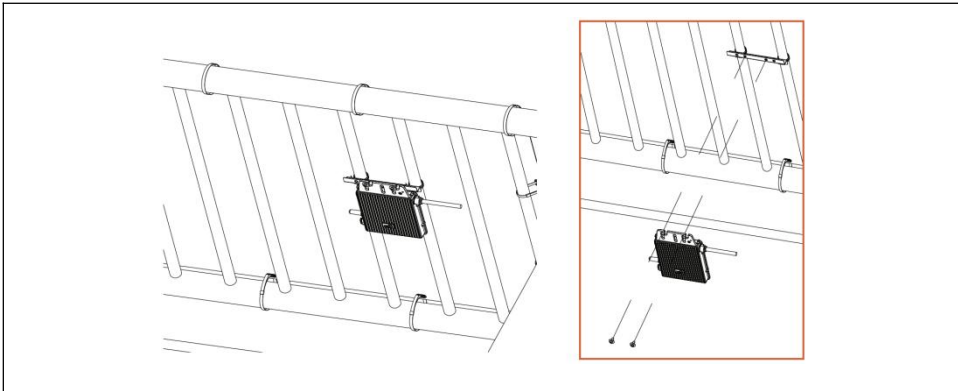

➤ Wall Installation

Using two pairs of screws and nuts to fix the microinverter on the frame.
Make sure that the label of microinverter should be upside.

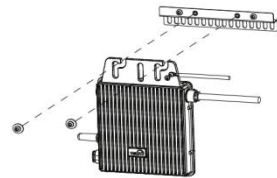

Step 3. Connect the ground cable.



- Ensure that all the microinverters are well grounded.
- Use $\phi 6$ screw for the ground port.

Connect the ground cable to the enclosure of the microinverter.

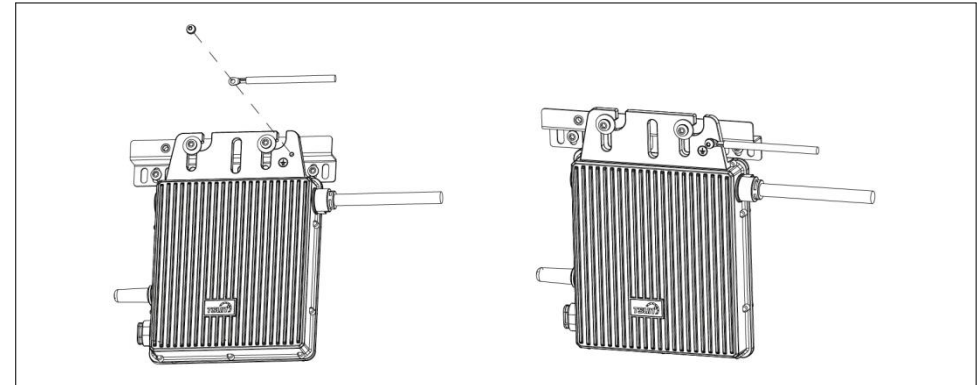

Step 4. Connect AC end cable



- Ensure that all AC cables are correctly wired and that none of the wires are pinched or damaged.

Rotate and connect the AC end of 5m AC End Cable with Plug (10m、15m optional) to the microinverter AC cable.

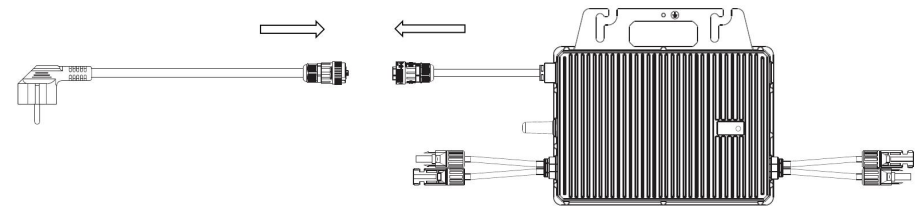

Step 5. Connect the DC cable



- When the photovoltaic array is exposed to light, it provides a DC voltage to the inverter.



·Ensure that all DC cables are correctly wired and that none of the wires are pinched or damaged.
 ·The maximum open circuit voltage of the PV module must not exceed the specified maximum input DC voltage of the TSOL microinverter.

**CAUTION**

·If the DC cable is too short for installation, use a DC Extension Cable to connect PV modules to the microinverter.
 ·Use MC4 compatible DC connectors in the inverter side of the DC extension cable, or get the DC connectors from TSUN.
 ·Contact PV module manufacturers for the requirements of the DC connectors in the module side of DC extension cable.

Install the PV modules and connect the DC cable to the microinverter.

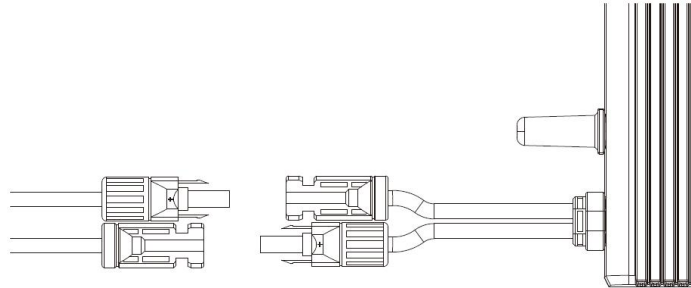

Step 6. Start the System

After plugging in the socket and connecting to the power supply. Your system will start producing power after about a two-minute wait time.

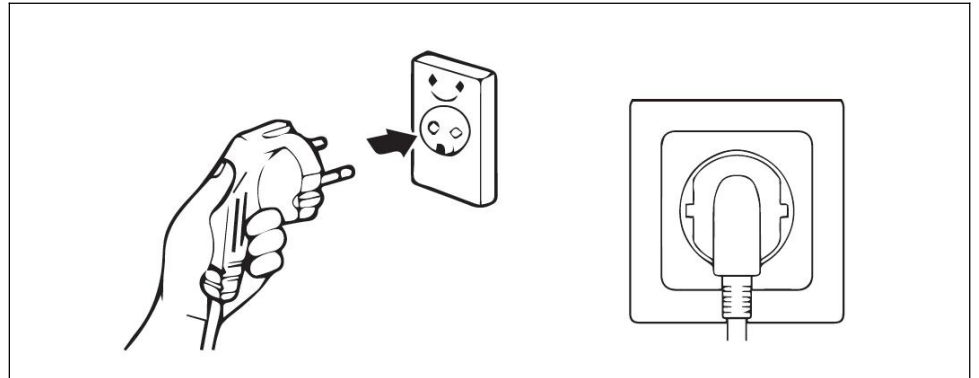

The LED will flash green and red at start-up. The definition of LED is shown below.

Status	Indicates
Flashing Green(0.2-0.8s)	Working normally
Flashing Red	Working abnormally
Solid Red	Fault

TSUN Smart Monitoring guide

APP DOWNLOAD

Scan the QR code. Download “TSUN Smart” App and install it on your smart phone.



REGISTER AN ACCOUNT

- Click to create an account, Choose “End-user”

- Fill in all registration details and read the T&C and Privacy Policy , then complete registration
- If you already have an account, log in directly
- If you don't remember your password, click "Forgot your password" to retrieve it

CREATE A PLANT AND ADD DEVICE

- Click **+ Add Plant** to create your own plant and fill in all the details
- Select "Device List" in the main menu and enter the device page
- Click **+ Add Device** to add a new device

Method 1: Scan the QR code

Method 2: Manually enter the serial number to add

(Note: Check the QR code on the backside of your microinverter)



Wi-Fi CONFIG

- Click **Wi-Fi CONFIG** on the device page
- Select microinverters and click "Start Config"
- Choose the WiFi and enter the password

(Note: Please check the password carefully)

- Click "Start Config" to configure the WiFi network

(Note: It may take 10 minutes to upload the data. Once completed, you can see the relevant data on the homepage)

Wi-Fi NETWORK REQUIREMENTS

- Use 2.4GHz or 2.4/5 GHz hybrid network
- Do not use VPN or proxy servers
- To understand the WiFi channel, please consult the local regulatory agency

COMMON PROBLEM

- WiFi name and password are incorrect
- Not using a 2.4GHz or 2.4/5GHz hybrid network
- Wrong network configuration steps
- Downloaded the wrong app
- bad network signal

(Note: If the fault cannot be eliminated after the above inspection, please contact after-sales service)

LAYOUT

- Click **Layout** the main page to create system layout
- You can see the physical layout of the plant and make bindings and electrical connections
- At the same time, you can switch to view the corresponding electrical layout
- We provide switching inquiries for power or production of your plant
- You can switch to query the monthly, yearly, and total data charts details according to the actual situation

AUTHORIZATION SETTINGS

- Click "Authorization settings" in the main menu
- Enter the company name or keywords and select the company you want to authorize
- After authorization, you can obtain some of your corresponding permissions

SWITCH PLANT

- Click "Switch plant" in the main menu and enter plant page
- Click "Create Plant" to add a new plant
- Choose the plant which you want to show on the home page
- Click "..." can delete plant

ME PAGE

- You can view the corresponding configuration items and view and use them according to the actual situation

Maintenance Guide

Routine Maintenance

- ◆ Only authorized personnel are allowed to carry out the maintenance operations and are responsible for reporting any anomalies.
- ◆ Always use the personal protective equipment provided by the employer when carrying out maintenance.
- ◆ During normal operation, check that the environmental and logistic conditions are appropriate. Make sure that the conditions have not changed over time and that the equipment is not exposed to adverse weather conditions and has not been covered with foreign bodies.
- ◆ DO NOT use the equipment if any problems are found and restore the normal conditions after the fault has been corrected.
- ◆ Conduct an annual inspection on various components and clean the equipment with a vacuum cleaner or special brushes.
- ◆ Do not attempt to dismantle the Micro-inverter or make any internal repairs! To preserve the integrity of safety and insulation, the Micro inverters are not designed to allow internal repairs!
- ◆ Maintenance operations must be carried out with the equipment disconnected from the grid (AC power switch off) and the photovoltaic modules shaded or isolated unless otherwise indicated.
- ◆ For cleaning, DO NOT use rags made of filamentary material or corrosive products that may corrode parts of the equipment or generate electrostatic charges.
- ◆ Avoid temporary repairs. All repairs should be carried out using only genuine spare parts.

Storage and Dismantling

- ◆ If the equipment is not used immediately or is stored for long periods, check whether it is correctly packed. The equipment must be stored in well-ventilated indoor areas that do not have characteristics that might damage the components of the equipment.
- ◆ Take a complete inspection when restarting after a long time or prolonged stop.
- ◆ Please dispose of the equipment properly after scrapping, as component parts are potentially

harmful to the environment, following the regulations in force in the country of installation.

Recycling and Disposal

This device should not be disposed of as residential waste. A Microinverter that has reached the end of its life is not required to be returned to the dealer. Users must find an approved collection and recycling facility in the area.

Warranty Service

We make the following commitments to Tsun's balcony products

- ◆ 144-month warranty commitment!
- ◆ During the warranty period of the warranty equipment, under normal use and maintenance, if the inverter itself has problems with the material and workmanship of the components and malfunctions, and it is verified to be true, the company will provide free repair and replacement.
- ◆ Product communication functions rely on local third-party communication operators. If problems such as data transmission failure and communication failure occur, Tsun will provide technical support but does not assume the final responsibility.
- ◆ Get instant Tsun product support on www.tsun-ess.com

In the following cases, no warranty service is provided

- ◆ The product was not installed correctly according to the installation instructions or was operated incorrectly, resulting in machine damage.
- ◆ It has been repaired, modified, or disassembled by non-company technical personnel.
- ◆ The serial number on the machine has been altered.
- ◆ Damage caused by negligent use or water or other substances penetrating into the machine.
- ◆ Failure or damage caused by external environment and natural disasters.

Technical Data

Model	TSOL-MX500 Balcony	TSOL-MX450 Balcony	TSOL-MX400 Balcony	TSOL-MS400 Balcony	TSOL-MS350 Balcony	TSOL-MS300 Balcony
Input Data (DC)						
Recommended Module Power (W)	300 ~ 700	300 ~ 700	300 ~ 700	300 ~ 550	300 ~ 550	300 ~ 550
Start-up Voltage per Input (V)	22					
Rated Input Voltage (V)	42					
MPPT Voltage Range per Input (V)	16~60					
Max. Input Voltage per Input (V)	60					
Max. Short-circuit Current per Input (A)	20	20	20	20	20	20
Max. Input Current per Input (A)	14	14	14	14	14	14
Quantity of MPPT	1	1	1	1	1	1
Max. Inverter Back-feed Current to the Array (A)	0					
Output Data (AC)						
Max. Output Power (VA)	500	450	400	400	350	300
Nominal Continuous Output Power (W)	500	450	400	400	350	300
Nominal Output Current (A)	2.17	1.96	1.74	1.74	1.52	1.3
Max. Output Current (A)	2.5	2.25	2	2	1.59	1.45
Nominal Output Voltage/Range (V)*	220/230/240, 175 – 270, L/N/PE					
Nominal Frequency (Hz)*	50/60					
Power Factor	>0.99 default, 0.8 leading ... 0.8 lagging					
Output Current Harmonic Distortion	<3%					
Mechanical Data						
Dimensions (W×H×D mm)	164 * 225 * 30					
Weight [kg]	1.75					

Model	TSOL-MX1000 Balcony	TSOL-MX900 Balcony	TSOL-MX800 Balcony	TSOL-MS800 Balcony	TSOL-MS700 Balcony	TSOL-MS600 Balcony
Input Data (DC)						
Recommended Module Power (W)	300 ~ 700	300 ~ 700	300 ~ 700	300 ~ 550	300 ~ 550	300 ~ 550
Start-up Voltage per Input (V)	22					
Rated Input Voltage (V)	42					
MPPT Voltage Range per Input (V)	16~60					
Max. Input Voltage per Input (V)	60					
Max. Short-circuit Current per Input (A)	20	20	20	20	20	20
Max. Input Current per Input (A)	14	14	14	14	14	14
Quantity of MPPT	2	2	2	2	2	2
Max. Inverter Back-feed Current to the Array (A)	0					
Output Data (AC)						
Max. Output Power (VA)	1000	900	800	800	700	600
Nominal Continuous Output Power (W)	1000	900	800	800	700	600
Nominal Output Current (A)	4.35	3.91	3.48	3.48	3.04	2.61
Max. Output Current (A)	5	4.5	4	4	3.19	3
Nominal Output Voltage/Range (V)*	220/230/240, 175 – 270, L/N/PE					
Nominal Frequency (Hz)*	50/60					
Power Factor	>0.99 default, 0.8 leading ... 0.8 lagging					
Output Current Harmonic Distortion	<3%					
Mechanical Data						
Dimensions (W×H×D mm)	250 * 223 * 30					
Weight [kg]	2.6					

Model	TSOL-MS2000 (600)	TSOL-MS2000 (800)	TSOL-MS1600	TSOL-MS1800	TSOL-MS2000
Input Data (DC)					
Recommended Module Power (W)	300 - 700	300 - 700	300 - 700	300 - 700+	300 - 700
Start-up Voltage per Input (V)	22				
Rated Input Voltage (V)	42				
MPPT Voltage Range per Input (V)	16~60				
Max. Input Voltage per Input (V)	60				
Max. Short-circuit Current per Input (A)	25	25	25	25	25
Max. Input Current per Input (A)	16	16	16	16	16
Quantity of MPPT	4	4	4	4	4
Max. Inverter Back-feed Current to the Array (A)	0				
Output Data (AC)					
Max. Output Power (VA)	600	800	1600	1800	2000
Nominal Continuous Output Power (W)	600	800	1600	1800	2000
Nominal Output Current (A)	2.61	3.48	6.96	7.83	8.70
Max. Output Current (A)	3	4	8	9	10
Nominal Output Voltage/Range (V)*	220/230/240, 175 – 270, L/N/PE				
Nominal Frequency (Hz)*	50/60				
Power Factor	>0.99 default, 0.8 leading ... 0.8 lagging				
Output Current Harmonic Distortion	<3%				
Mechanical Data					
Dimensions (W×H×D mm)	331 * 261 * 44				
Weight [kg]	5				

General Data for all Balcony Microinverter	
Peak Inverter Efficiency	96.7%
CEC Weighted Efficiency	96.5%
Nominal Mppt Efficiency	99.9%
Nighttime Power Consumption	<50mW
Display	LED indicators; TSUN APP+WEB
Communication	built-in WiFi module
Type of Isolation	Galvanically Isolated HF Transformer
Type of Enclosure	IP67
Cooling	Natural convection
Operating Ambient Temperature Range	-40 ~ +65 (derating of over 50°C Ambient Temperature)
Relative Humidity	100%
Max. Operating Altitude Without Derating [m]	2000

WiFi module for all Balcony Microinverter	
WiFi Standard	802.11b/g/n
WiFi Frequency Range	2.412GHz-2.472GHz
WiFi Transmitting Power	802.11b: +17dBm + 1.5dBm (@11Mbps)
	802.11g: +15dBm + 1.5dBm (@54Mbps)
	802.11n: +14dBm + 1.5dBm (@HT20, MCS7)
WiFi Receiving Sensitivity	802.11b: -96dBm (@1Mbps)
	802.11b: -89dBm (@11Mbps)
	802.11g: -91dBm (@6Mbps)
	802.11g: -76dBm (@54Mbps)
	802.11n: -91dBm (@MCS0)
	802.11n: -73dBm (@MCS7)
BLE Standard	BLE5.0
BLE Frequency Range	2.402GHz-2.480GHz
BLE Transmitting Power	Max 15dBm
BLE Receiving Sensitivity	-97 dBm



TSUNESS Co., Ltd

 www.tsun-ess.com

 sales@tsun-ess.com

 2F, Building 2, No. 55 Aigehao Road, Xiangcheng District, Suzhou, China