

# DDZY422-D2-W WiFi Smart Meter\_User Manual\_EN

## Update Instructions

This section records the updates of the Smart Meter User Manual.

Version	Update Date	Content
V1.0	2024-11-8	Initial version



## Read Before Use

This manual contains important instructions for Smart Meter, which must be read completely before installing or debugging the equipment. For safety reasons, only qualified technicians who have been trained or have proven skills can install and maintain this Smart Meter under the guidance of this document.

This manual is applicable to the following products:

Model	Communication	Installation Mode	Wiring Mode
DDZY422-D2-W	WiFi	DIN Rail	Direct-connected

The following security symbols are used in this manual. Before installing or operating the system, familiarize yourself with these symbols and their meanings.

Identification	Explanation
	<b>Danger:</b> Danger indicates a dangerous situation that may cause fatal electric shock, other serious personal injury, or fire danger.
	<b>Warning:</b> Warnings indicate instructions that must be fully understood and followed to avoid potential safety hazards, including equipment damage or personal injury.



**Note:**

Notes indicate that the described operation should not be performed. Before continuing, readers should stop using and fully understand the explained operation.

# Product Introduction

## System Introduction

Smart Meter is a power meter that uses WIFI communication. It is installed in the home distribution box, collects voltage, current, power and other information of the power grid, and transmits it to microinverter or micro storage unit through the WIFI network. It assists microinverter or micro storage unit in performing control functions such as zero-export function.

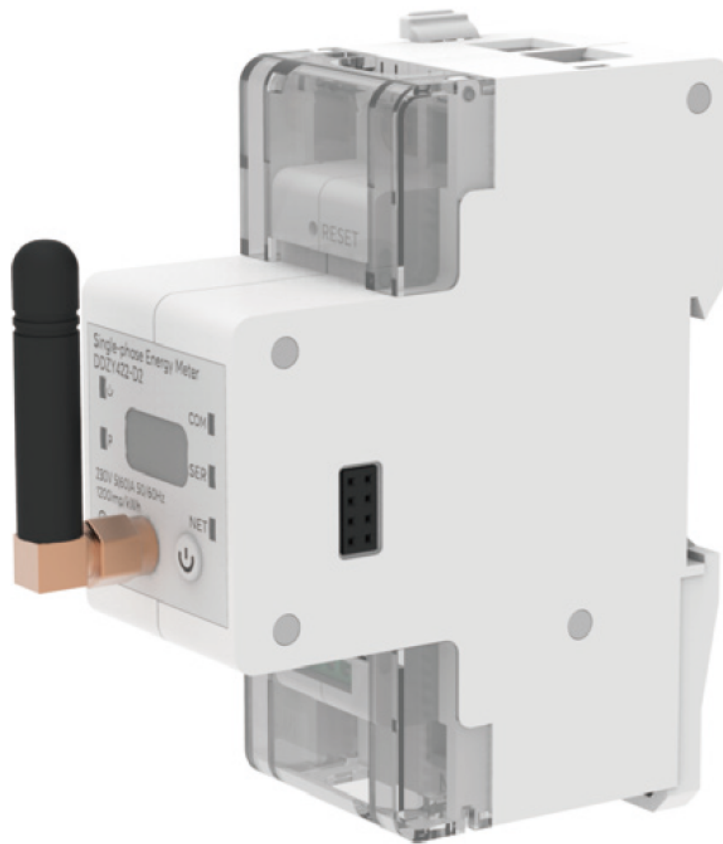

### Example 1: Smart Meter and Energy Storage Systems

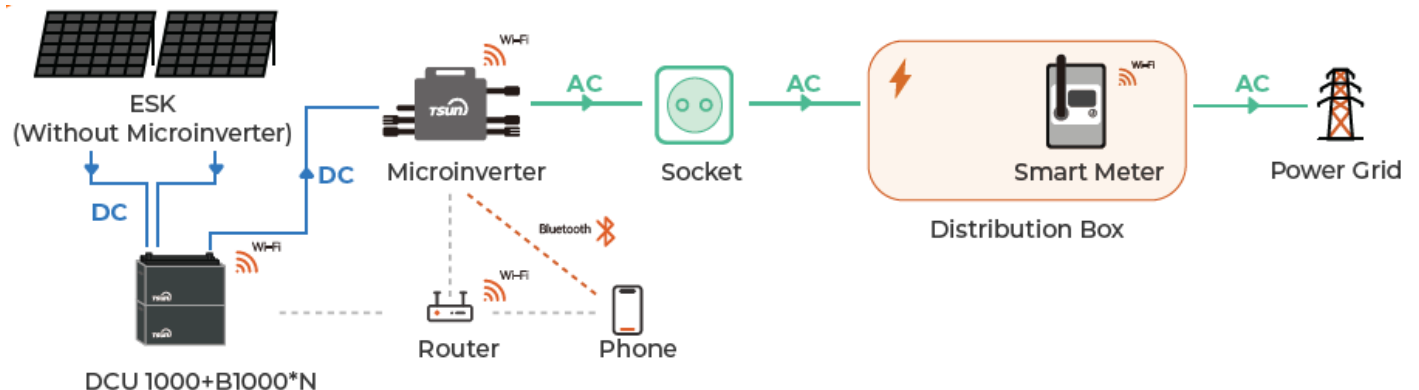

## Example 2: Smart Meter and Microinverter Systems

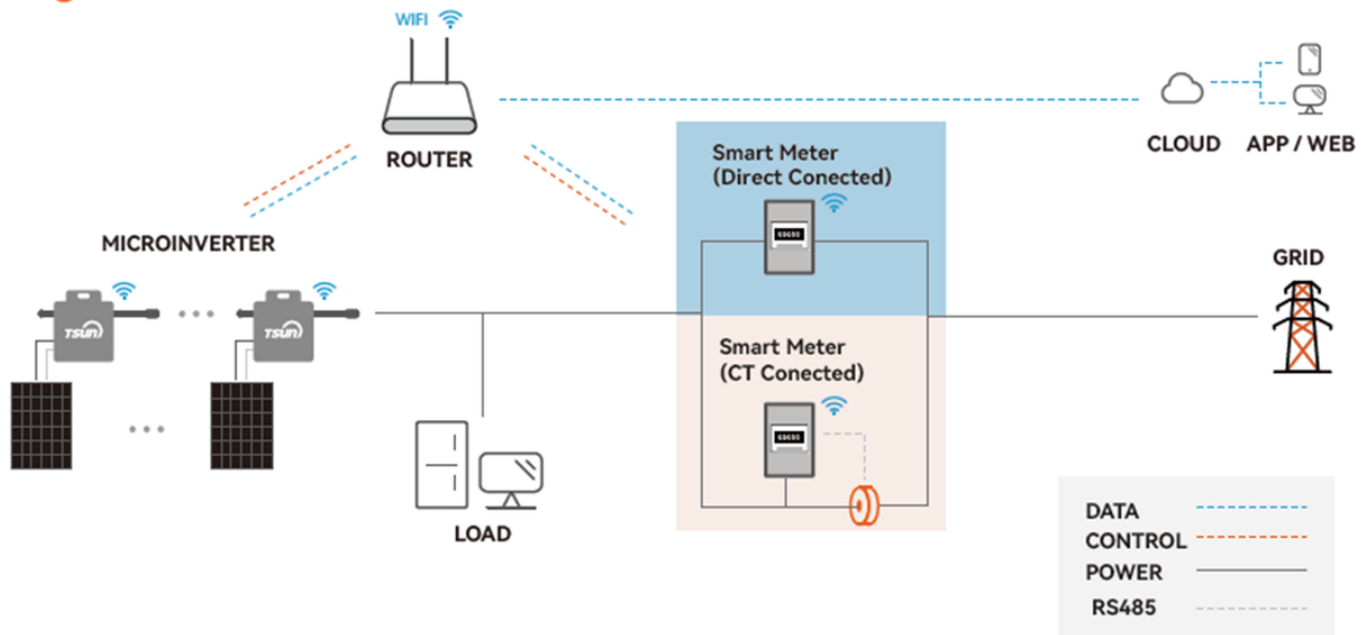

## Product Introduction

### Screen Display

Display Panel (Note: “\*” represents single number, “#” represents “-” .)

Flip-screen Mode: Auto-flip in 2s/Click to flip the screen.

No.	Content	Display Form	Unit
1	Positive Active Total Energy (High 4-bit)	****	kWh
2	Positive Active Total Energy (Low 4-bit)(Two decimal )	**.**. .	kWh
3	MODBUS COM Address	A ***	
4	Voltage	U ***	V
5	Current	L #**	A
6	Power	P #**	kW
7	Power Factor	PF *.*	
8	Frequency	F **.	

Display of Positive Active Total Energy (4-bit liquid crystal,2 decimal)

Energy is less than 99.99, E.g. “68.52” :





Energy is more than 99.99, E.g. “220968.52” :



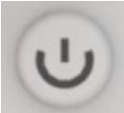
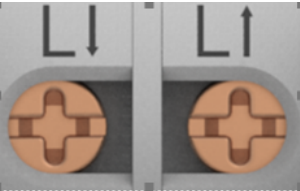

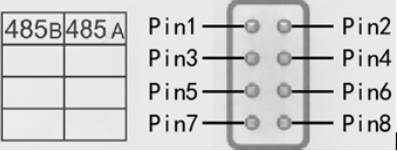
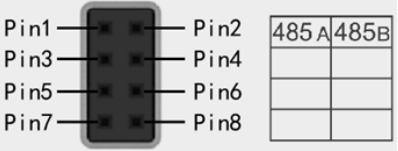
## Interface Definition



		Power	Turn off: Press for 3s Turn on: Press for 3s
	A	RS485 A data transmission and reception	Address 001, 9600bps, E, 8, 1
	B	RS485 B data transmission and reception	
	+	Pulse port	Calibration Interface
	-	Pulse port	
	L ↓	L Line In (connect to the power grid side)	L Line Interface
	L ↑	L Line Out (connect to the load side)	
	N	N Line In&Out	N Line Interface

			
	Pin1	RS485 B data transmission and reception	Address 001, 9600bps, E, 8, 1
	Pin2	RS485 A data transmission and reception	
	Pin3-8	No function	
	Pin1	RS485 A data transmission and reception	Address 001, 9600bps, E, 8, 1
	Pin2	RS485 B data transmission and reception	
	Pin3-8	No function	
		Reset button	Restart(5s)/Reset(10s)

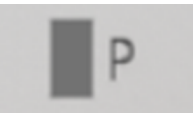
Notice: RS485A, RS485B of Pin,Female Header are directly connected.

## Indicator Lights

Indication	Identification	Status
	Power (Green)	1. Off: This meter is turned off. 2. On: This meter is turned on.
	Energy Light (Red)	Flash: According to consumption status.(1200 times means 1kWh)
	Communication between meter and WiFi module (Green)	1.On: Connected to meter. 2.On 400ms/Off 400ms: Data transmitting. 3.Off: Fail to communicate with to meter.
		1.On: Connected to server.

	Communication between WiFi module and server (Green)	2.On 400ms/Off 400ms: Connected to router, not connected to server. 3.Off: Fail to connect to router.
	Running Statu (Green)	1.On 64ms/Off 2000ms: WiFi module runs normally. 2.Off: WiFi module runs abnormally.

## Product Installation

### Confirm the Phase of the Circuit

If this smart meter is installed on a single-phase power grid, ignore this section and proceed to the next step, "Install the Smart Meter".

If this smart meter is installed on a three-phase power grid, it is necessary to confirm the installation position of the meter according to the following method. Confirm the corresponding switch and the phase of the microinverter or micro storage unit in the household distribution box. As shown in the figure below, it is necessary to confirm which phase of the microinverter or micro storage unit is in. The smart meter must be installed next to the electricity meter. When the meter is in the same phase as the corresponding microinverter or micro storage unit, the microinverter or micro storage unit can turn on the zero export function.

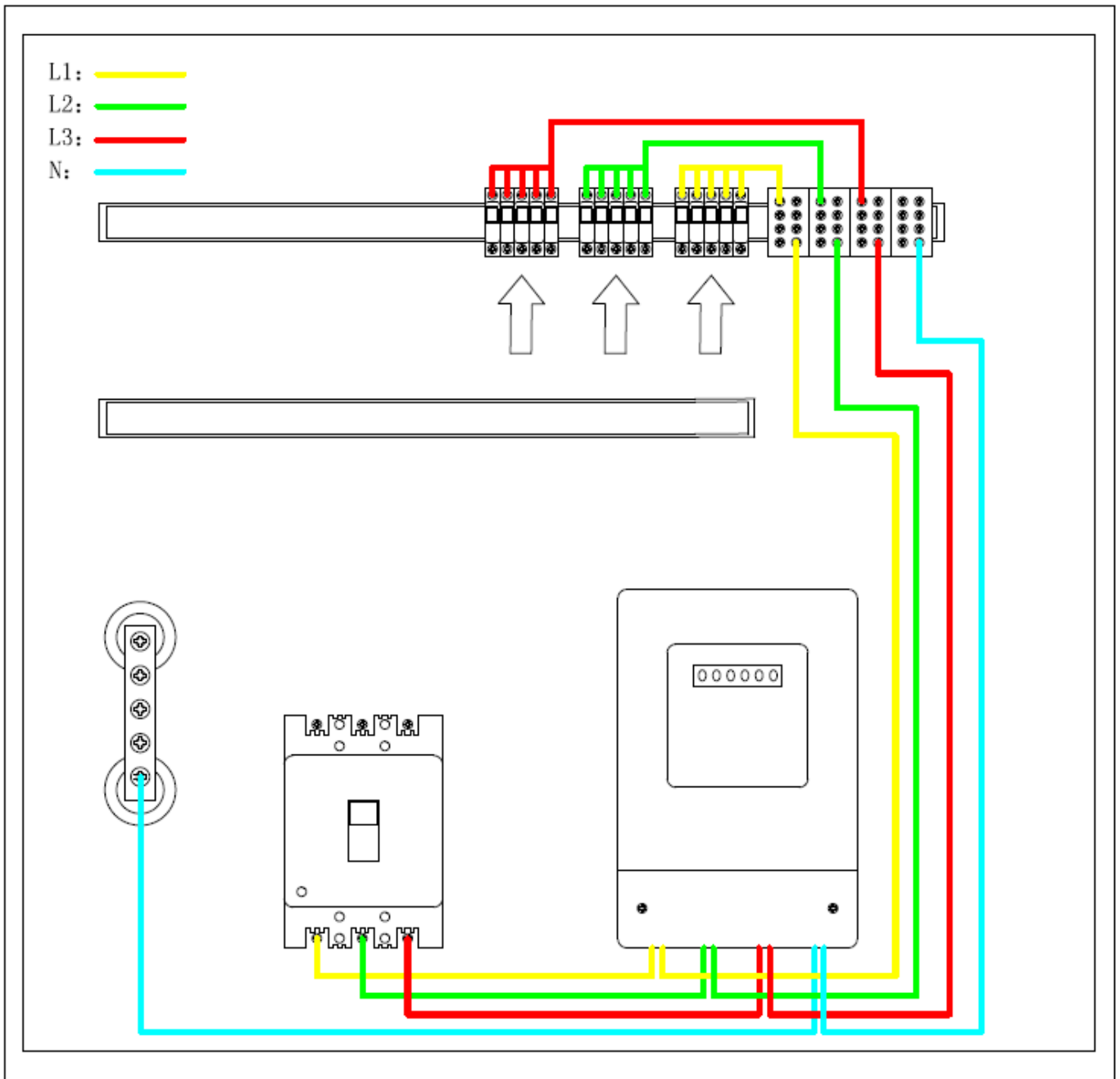

- Method 1:

If the circuits or devices controlled by each switch are clearly marked on each single-phase switch in the household distribution box, the installer can directly find the circuit switch that controls the microinverter or micro storage unit.

- Method 2:

If the control circuit of each single - phase switch in the household distribution box cannot be clearly distinguished, the installer can consult the household about the house power grid wiring diagram, obtain relevant information by querying the drawing, and find the circuit switch that controls the microinverter or micro storage unit.

- Method 3:

If relevant information cannot be found in the distribution box or drawing materials, the installer can quickly find the corresponding circuit switch according to the following steps.

1. Step 1: Connect an easily-observable household appliance (such as an electric fan, desk lamp, etc.) to the socket that is ready to have the microinverter or micro storage unit installed.
2. Step 2: Turn on the household appliance and put it in working mode (for example, turning on the electric fan or desk lamp).
3. Step 3: Turn off the single-phase switches in the household distribution box one after another, and observe the status of household appliances at the same time. If the household appliance used for observation stops working after closing a single-phase switch (for example, the electric fan stops rotating, the desk lamp goes out), then the single-phase switch is the control switch of the corresponding circuit.

After finding the corresponding circuit switch, install the smart meter on the bus (or connection line) between the three-phase switch and the single-phase switch. For example, if the smart meter is installed in the L1 phase, the wiring should be as follows.



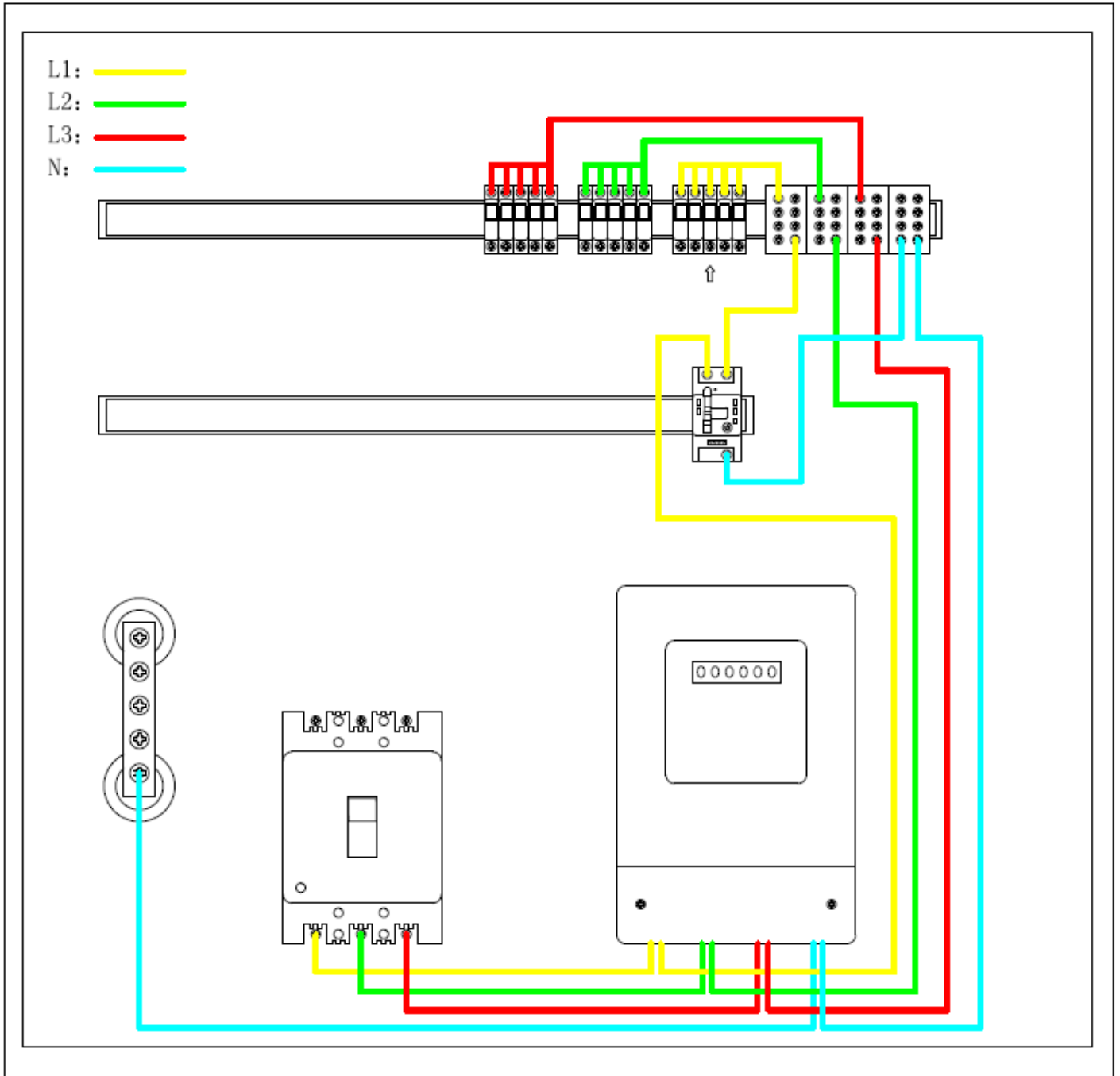

**Warning:**

The maximum passing current of the Smart Meter is 60A. The load current in this circuit cannot exceed this upper limit.

## Install the Smart Meter

- Step 1: Turn off the three-phase switch and all single-phase switches of the distribution box.



**Danger:**

Installers must ensure that the three-phase switch as well as all other switches remain in a closed state during the whole operation process. Meanwhile, be cautious not to touch

the exposed conductive part on the grid - side of the three - phase switch to prevent electric shock.

- Step 2: Install the Smart Meter on the rail of the distribution box.

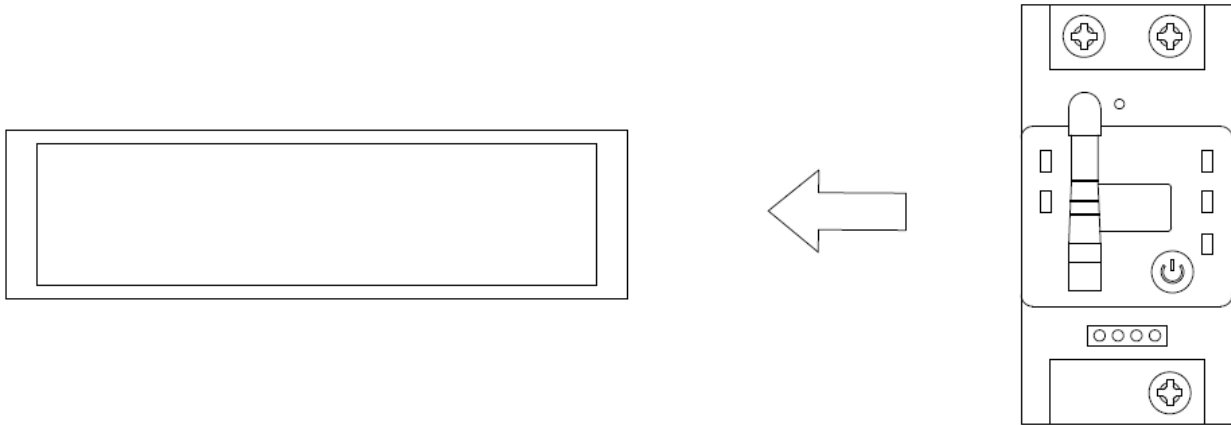

- Step 3: Connect the L (live wire) line of the three - phase switch to the L ↓ port of the Smart Meter, where L ↓ is the input port, from the power grid to the meter. Connect the L (live wire) line of the single - phase switch to the L ↑ port of the Smart Meter, where L ↑ is the output port, from the meter to the household load. Connect the N (neutral wire) line to the N port of the Smart Meter.

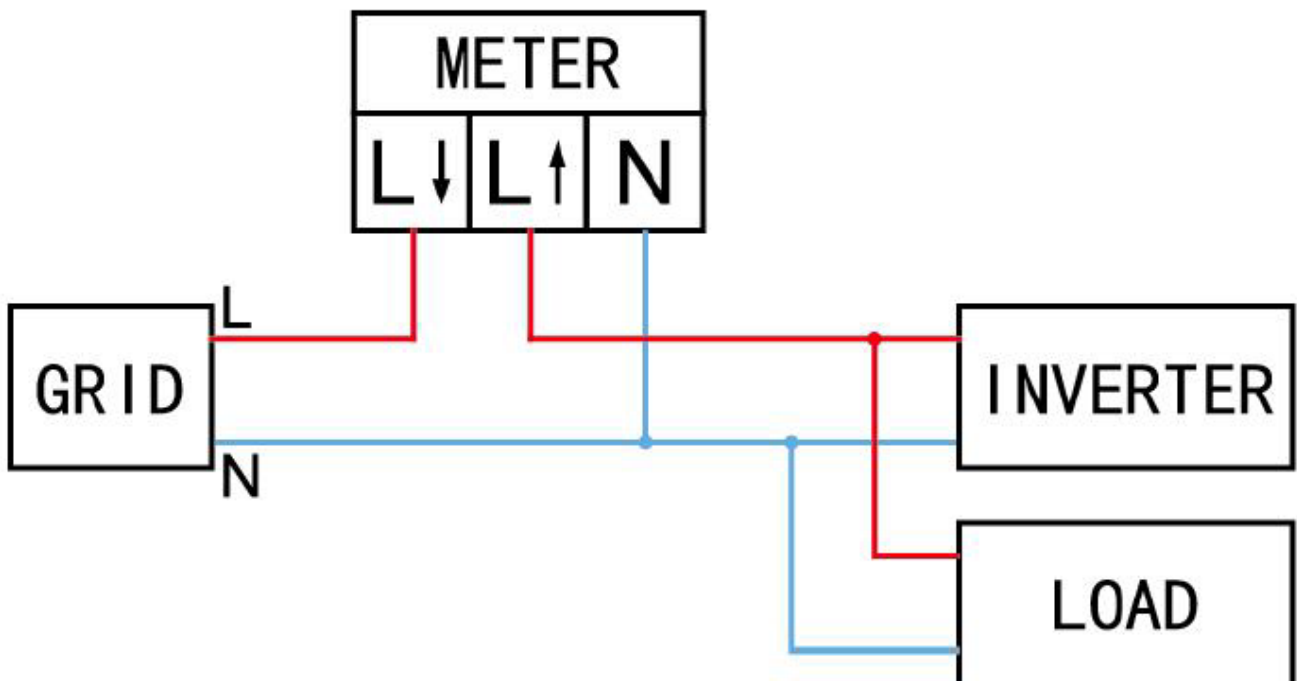

- Step 4: After confirming that the wiring of the meter is correct, turn on the three-phase switch and the single-phase switch.

## Monitoring System

### Download and Install APP

Download and install the "TSUN Smart" APP.

1. IOS users can directly search for "TSUN Smart" in the APP Store and download the software.
2. Android users can directly search for "TSUN Smart" in Google Play and download the software.
3. Android users who cannot access Google Play can scan the QR code below to download and install "TSUN Smart".



Register an account and log into the APP.

When registering, you can choose to be an installer or an end-user.

The rooftop solar plant which uses microinverters needs to be built by a professional installer. Please register as an "installer" and follow the subsequent instructions to execute the APP operation.

The DIY balcony storage plant which uses micro storage units is built by end - users, but the installation of smart meter still needs to be done by professionals. Please register as "end - users" and follow the subsequent instructions to execute the APP operation.

English



# Register



E-mail

Username

demo@tsun-ess.com

Please enter password

I have read and agreed [T&Cs](#) and [Privacy Policy](#)

Log In

Register

Forgot your password?



**I am a Distributor or Installer**



**I am an End User**

V1.0.6

## Operation Steps (Professional Installer + Microinverter)

- Step 1: Click "+" to create a solar plant. After filling in the plant information, click "Save" to complete the solar plant creation.

	<b>Note:</b>
The system type is "Photovoltaic + Grid + Load".	

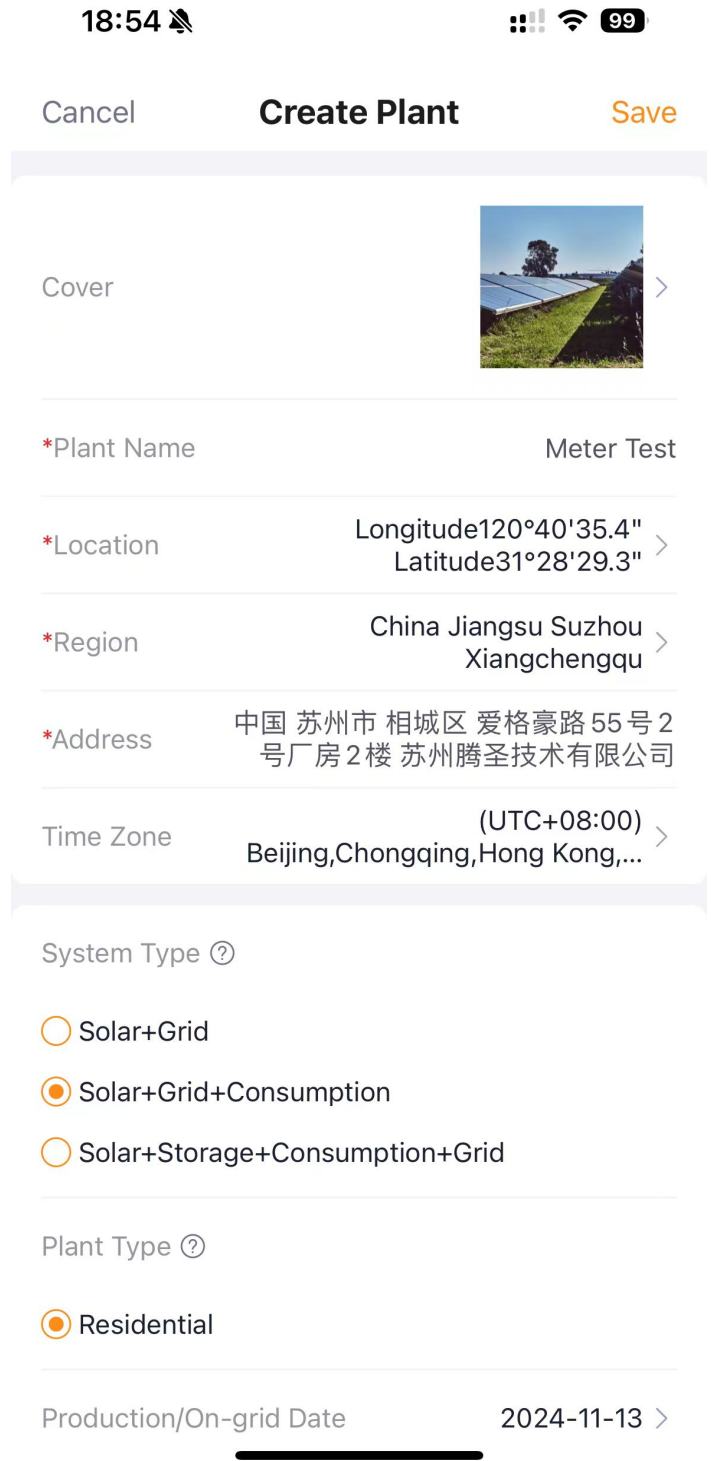
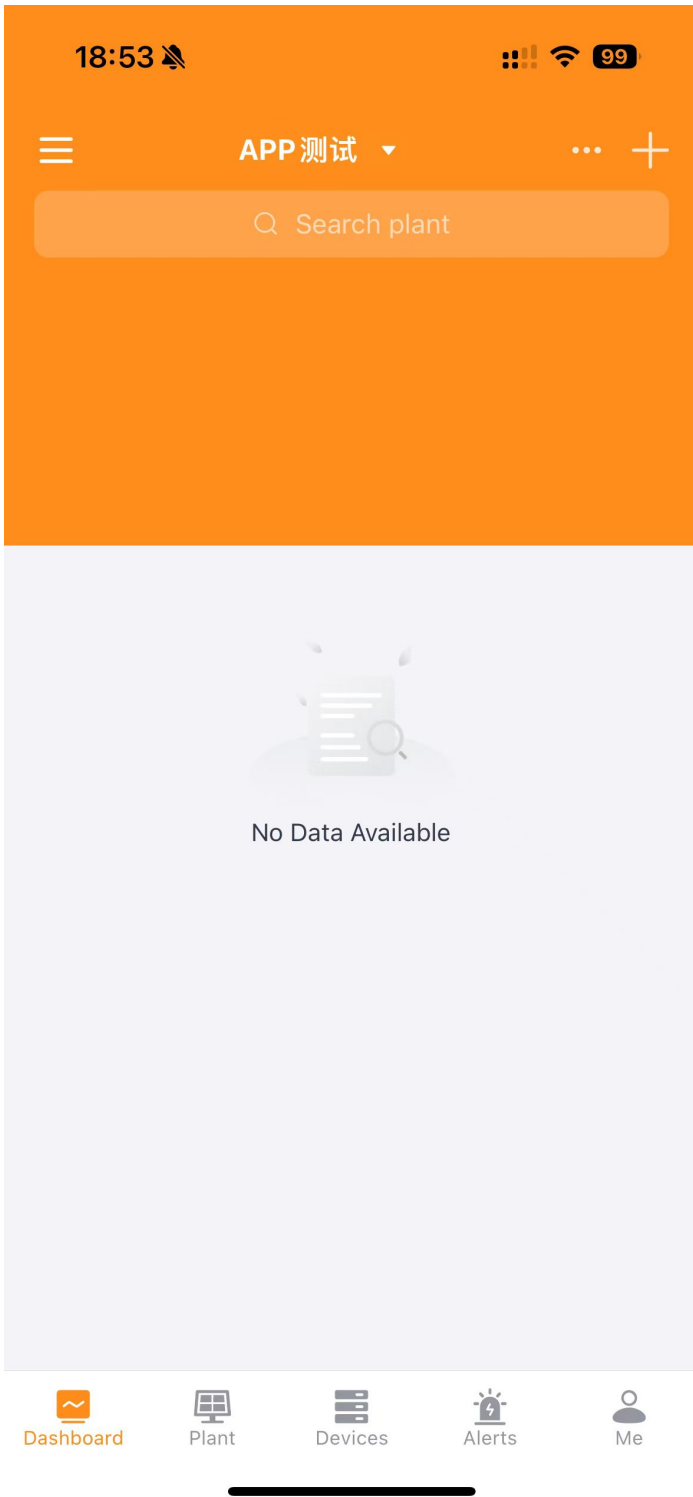

- Click "Add Datalogger" and scan the QR code on the meter to complete the device addition.

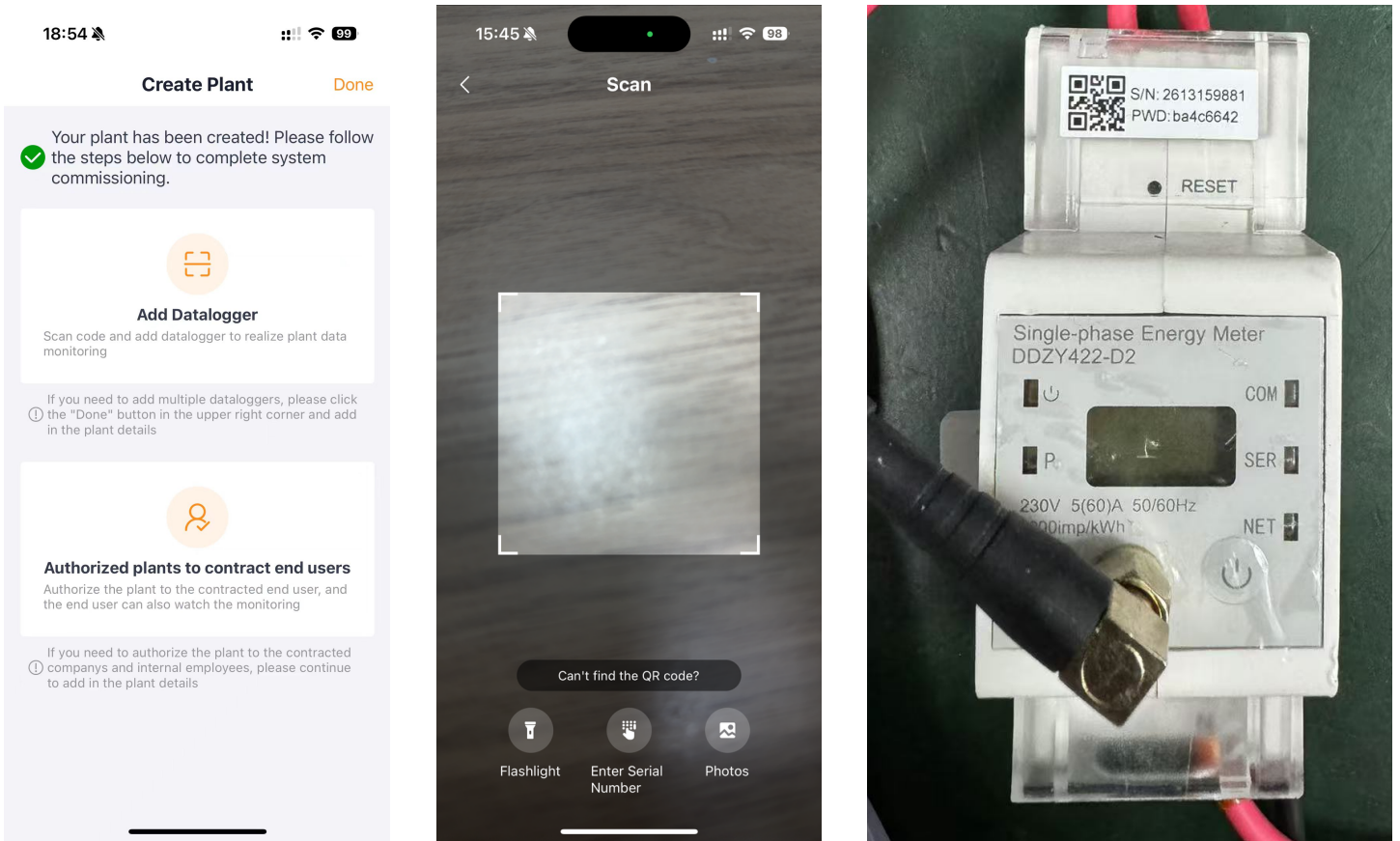

- First, click "..." in the upper right corner and select "WiFi Configuration". Then select the corresponding meter and click "Start Config". Finally, select the WiFi you want to connect to, enter the WiFi password and click "Start Config" again.

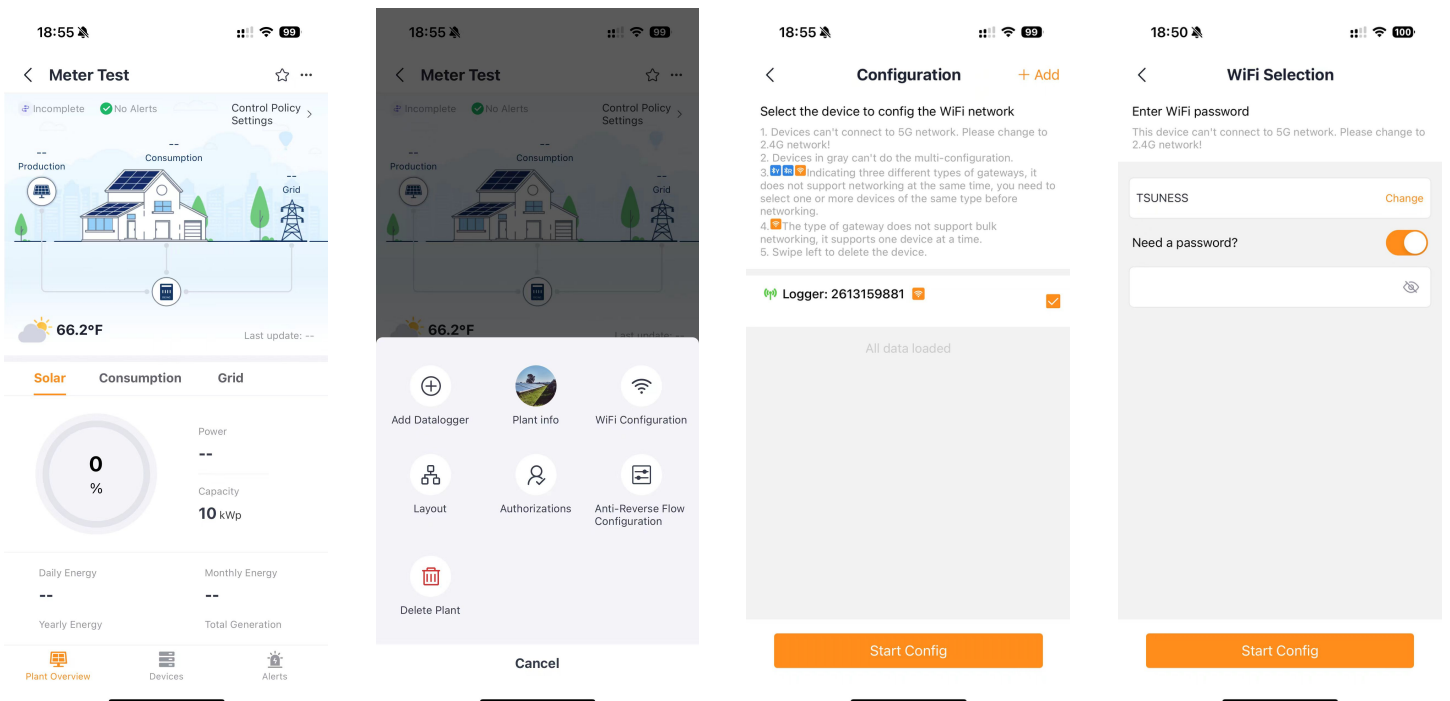

According to the prompt, click "Connect" to jump to the wireless network interface. Select "AP\_XXXXXXXXXX" hotspot. Enter the hotspot password and connect to the hotspot.

	<p><b>Note:</b></p>
--	---------------------

The names of hotspots are named in the form of AP + meter serial number.

The password of the hotspot can be found on the SN label of the meter.

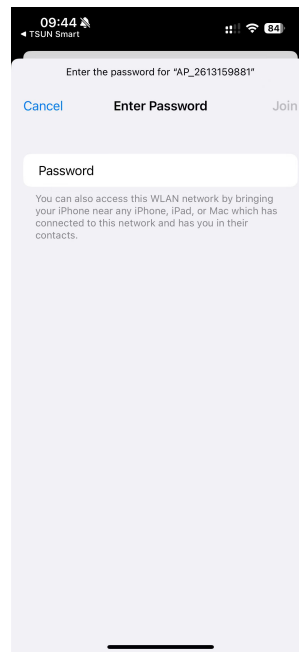
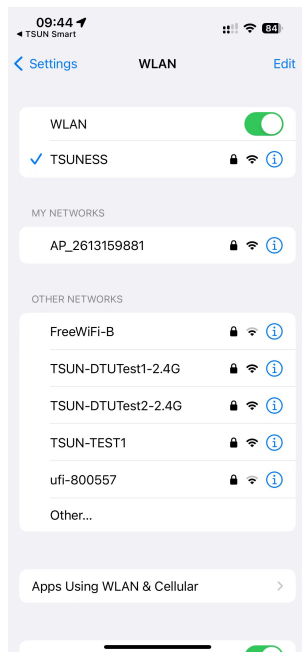
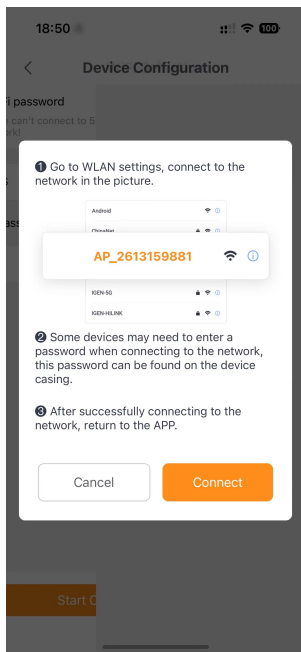

After the hotspot connection is successfully established, return to the TSUN Smart APP. At this point, the meter will enter the WiFi configuration process. After approximately 60 seconds, the WiFi configuration will be completed successfully, and the meter data will be uploaded to the server.

18:51



## Device Configuration

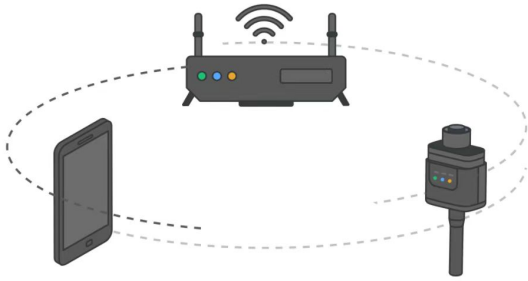

Please keep your phone close to the device.

Logger 2613159881

Configuring

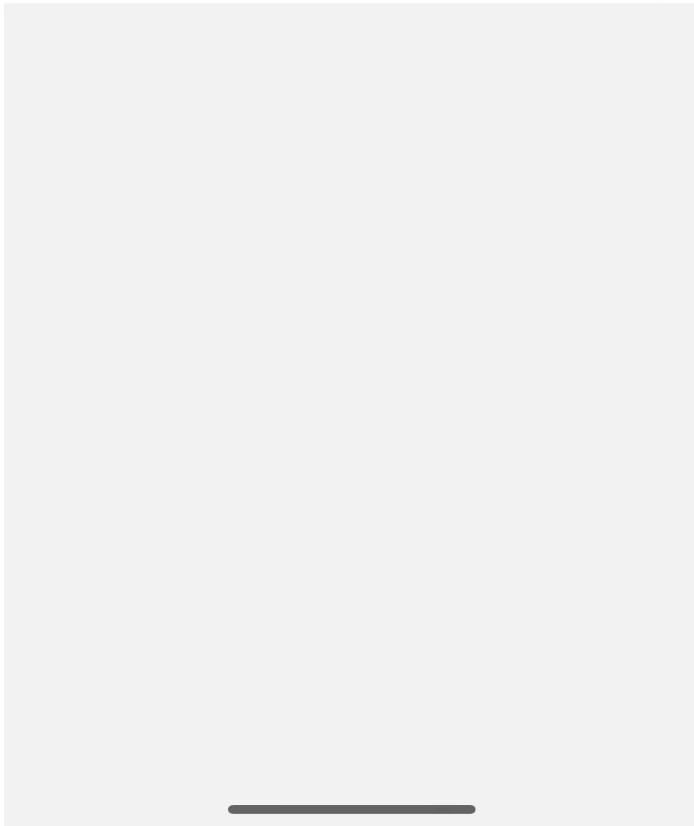

18:52



## Device Configuration



### Configuration Successful

All devices connected to the network successfully.

Completed Configuration

- Step 4: Click “...” on the plant home page and click “Anti-Reverse Flow Configuration” .Choose “Turn On” and set the total plant power and offset value (Normally set to 0 W). Reconfirm all the information and click “OK” . Waiting for around 300 seconds and complete this configuration.Check the status in the device list after the configuration.



**Note:**

All devices must be online during the configuration.

If there are any issues, you can try reconfiguring.



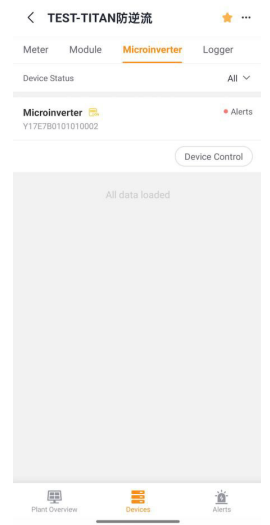
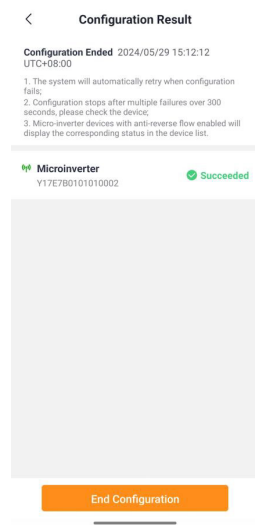
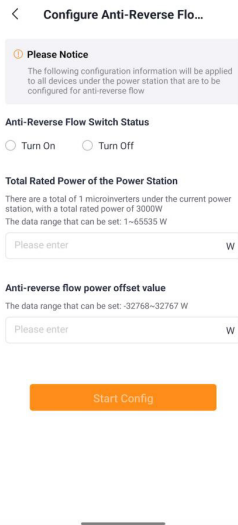
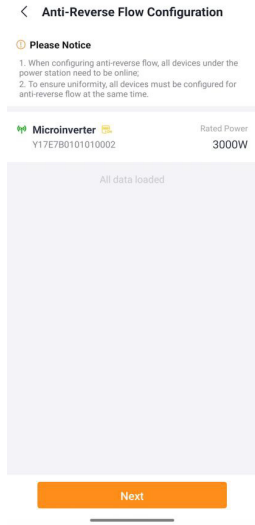
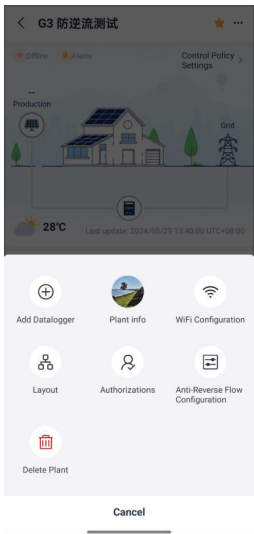

## Operation Steps (DIY End-Users + Micro Storage Unit)

- Step 1: Click "Create Plant". After filling in the plant information, click "Save" to complete the plant creation.

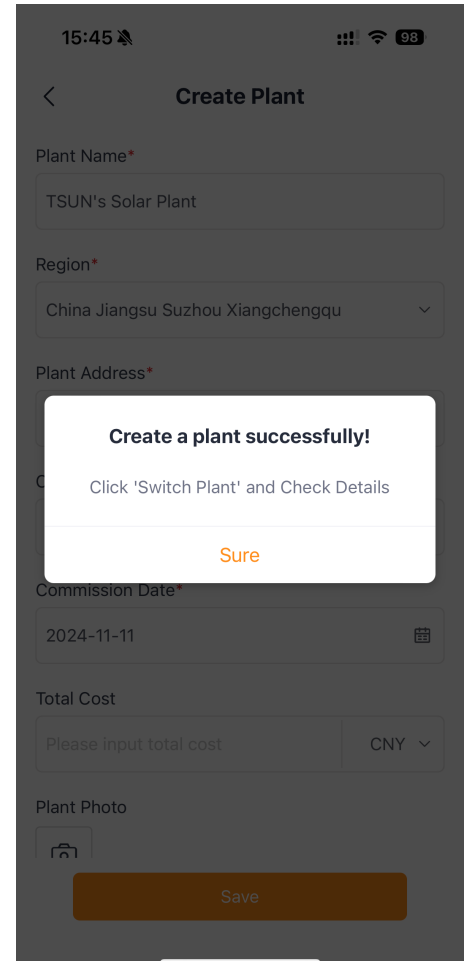
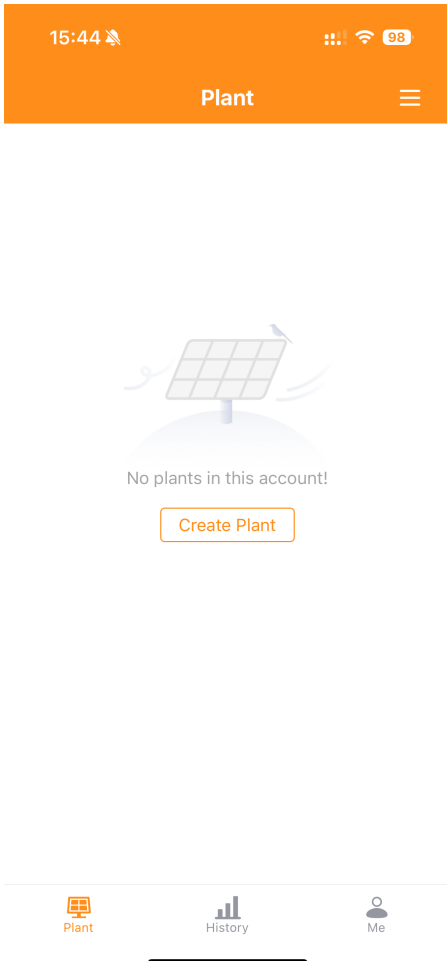

- First, click "☒" in the upper right corner and then select "Device List". Next, click "Add Device" and under the "Accessories" menu, select "Smart Meter" device. Finally, scan the QR code on the meter to complete the device addition.

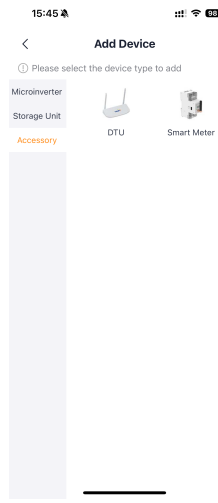
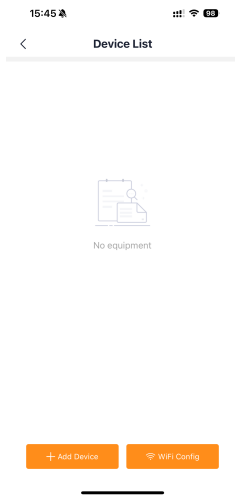
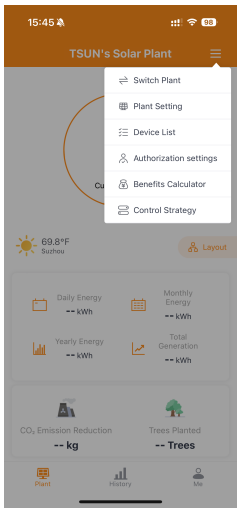

- Step 3: In the "Device List", click "WiFi Config". Select the corresponding meter and click "Start Config". Select the WiFi you want to connect to, enter the WiFi password, and click "Start Config" again.

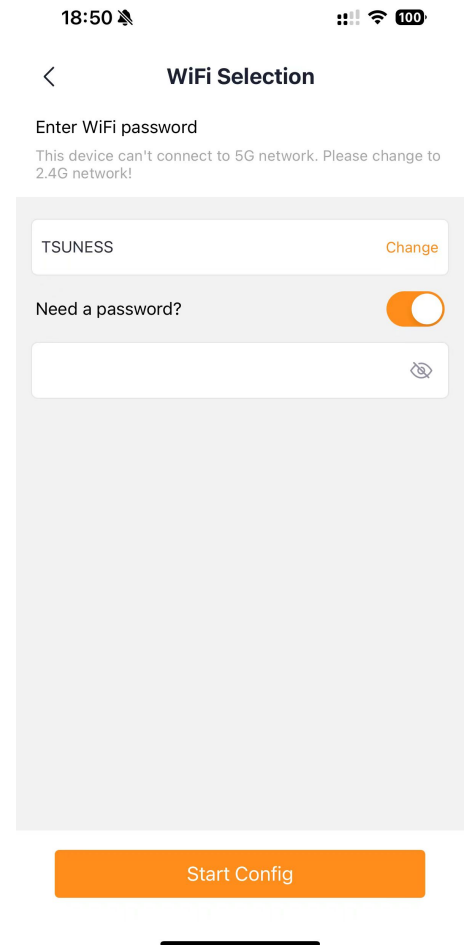
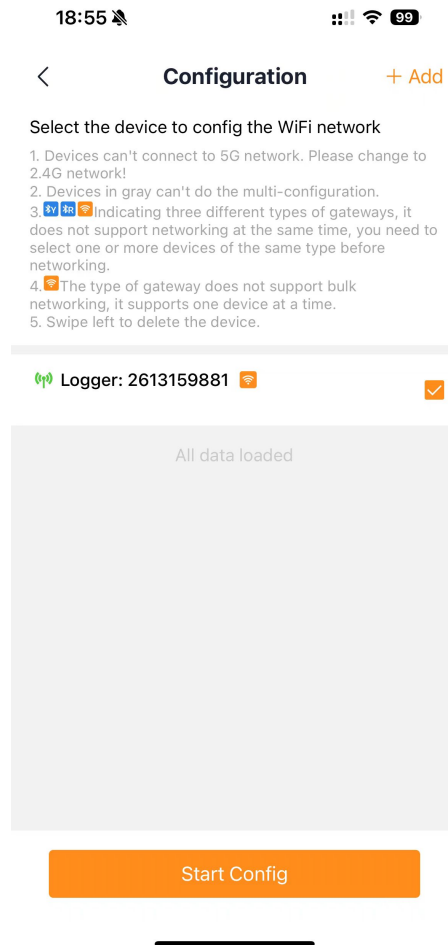
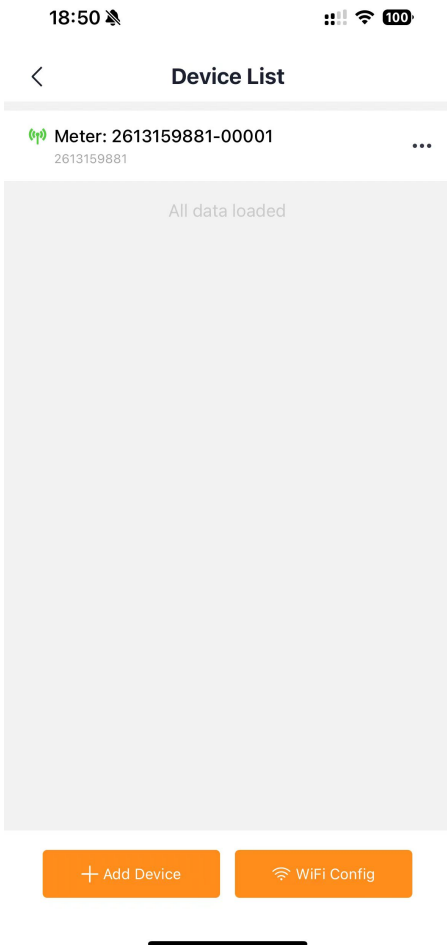

According to the prompt, click "Connect" to jump to the wireless network interface. Select "AP\_XXXXXXXX" hotspot. Enter the hotspot password and connect to the hotspot.

	<p><b>Note:</b></p> <p>The names of hotspots are named in the form of AP + meter serial number.</p> <p>The password of the hotspot can be found on the SN label of the meter.</p>
---	---

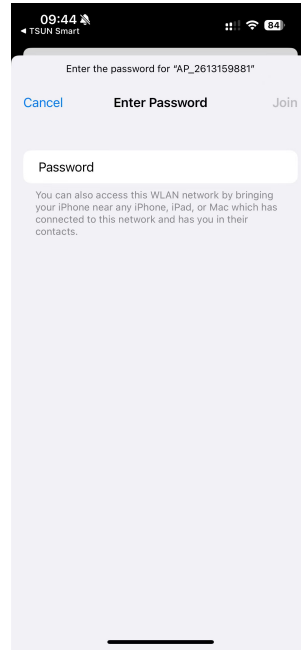
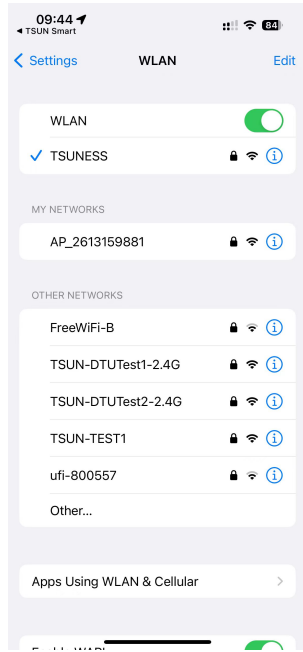
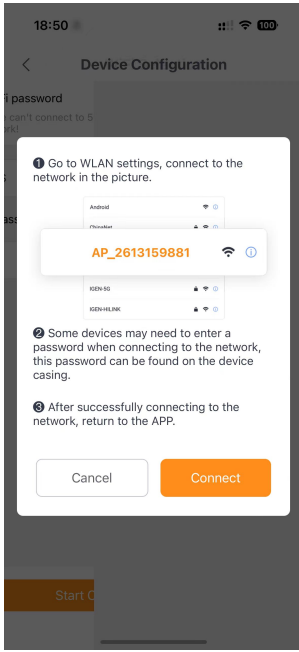

After the hotspot connection is successfully established, return to the TSUN Smart APP. At this point, the meter will enter the WiFi configuration process. After approximately 10 seconds, the WiFi configuration will be completed successfully, and the meter data will be uploaded to the server.

18:51



## < Device Configuration

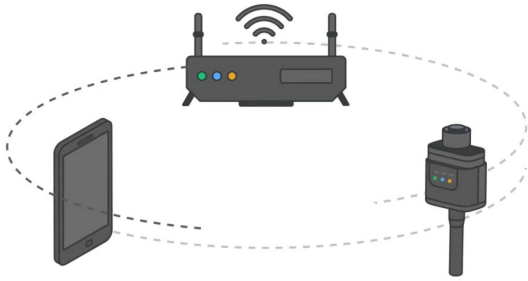

Please keep your phone close to the device.

**Logger**   
2613159881

Configuring

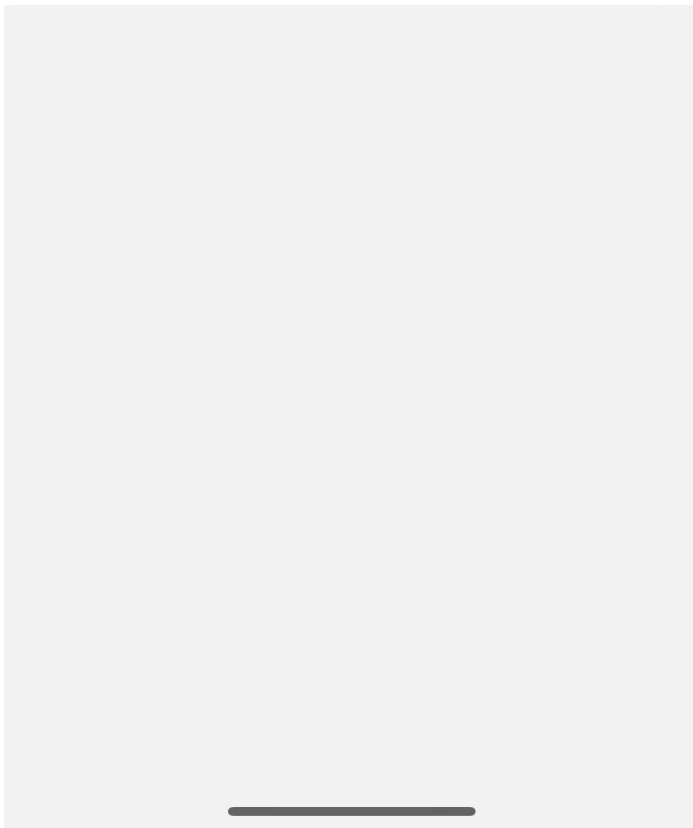

18:52



## < Device Configuration



### Configuration Successful

All devices connected to the network successfully.

Completed Configuration

- Step 4: Click “” on the plant home page and click “Control Strategy” . Click “Go to Contiguration” . Turn on the Anti-Reverse Flow Contiguration.

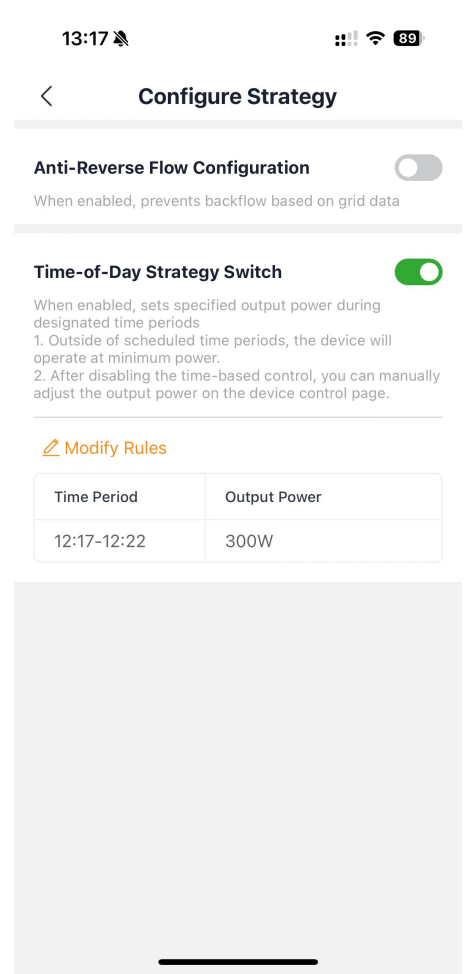
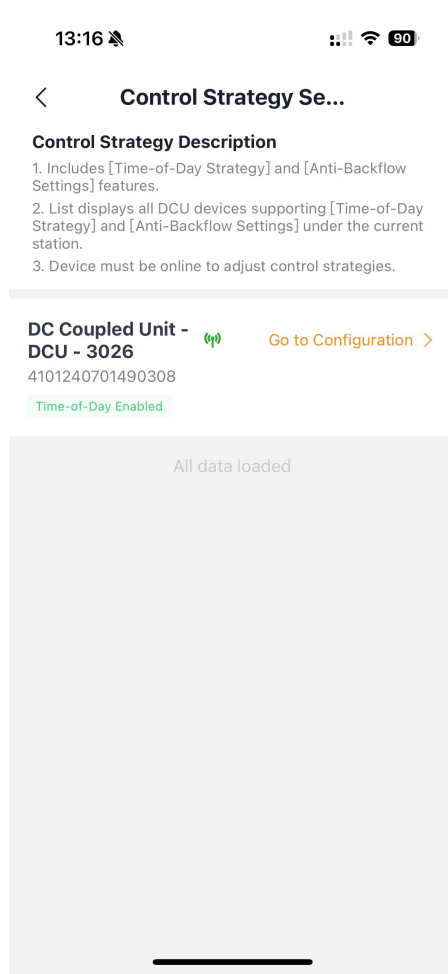
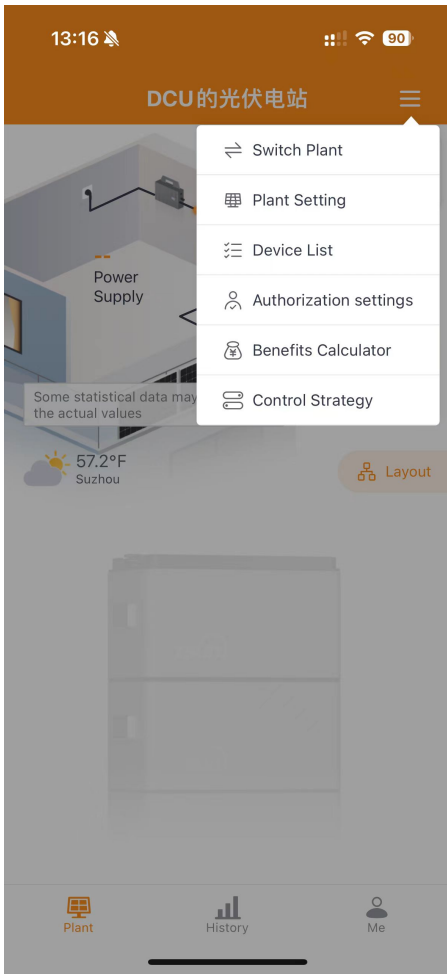

## Appendix:

### DDZY422-D2-W

	Parameter	Value	
Communication	Wireless type	WiFi	
	Wireless standard	802.11 b/g/n	
	Frequency range	2.412GHz-2.484GHz	
	Transmit power		802.11b: +16 +/-2dBm(@11Mbps)
			802.11g: +14+/-2dBm(@54Mbps)
			802.11n: +13+/-2dBm(@HT20, MCS7)
Antenna		SMA Little Pepper WIFI Antenna	
		RS485	

	Local serial communication	
	Serial communication parameter	Address 001, 9600bps, E, 8, 1
	Data upload interval	5 minutes
Meter	Rated Voltage	230V AC
	Rated Current	5(60)A
	Rated Frequency	50/60Hz
	Power Range	0~999999.99kWh
	Accuracy Level	1.0
	Consumption	≤3.5W
	Pulse Constant	1200imp/kWh
Environment	Operating Temperature	Normal working temperature: -30 °C~ + 70 °C Maximum operating temperature: -40 °C~ + 85 °C
	Relative Humidity	≤ 85% (no condensation), altitude below 3000 meters
	Atmospheric Pressure	70kPa~106kPa
	Storage& Transportation	Temperature -40 °C~ 85 °C, Relative Humidity ≤ 85%